

Group 100/6

Low Energy Nuclear Physics

Group Members

Head of group: Ivetta Kerobyan

1. Gharibyan Yu.

2. Bazoyan G.

3. Avetisyan R.

4. Hakobyan Margarita –second year of Master

5. Yaralov V.

6. Hakobyan Marieta

Ivanyan V. - first year of Master

*1. GEANT, TALYS, EMPIRE, SRIM, TRIM ,
SSSM*

*2. Excitation Functions of Protons Induced
Reactions on Cyclotron C18*

*3. Investigation of Possibility Obtaining
Neutron Beams on C18*

TENDL2012



**TALYS-based
Evaluated Nuclear
Data
Library**

***TENDL** is a nuclear data library which provides the output of the TALYS nuclear model code system for direct use in both basic physics and applications.*

***TENDL** contains evaluations for seven types of incident particles, for all isotopes living longer than 1 second (about 2400 isotopes), up to 200 MeV.*

EMPIRE-3.1 (Rivoli)

Nuclear Reaction Model Code

Neutron Resonances

Coupled Channels

DWBA

Optical Model

Multistep Direct

Multistep Compound

Exciton Model

Hybrid MC Simulation

HRTW

Hauser-Feshbach

Optical Model for Fission



A 3D graphic featuring the acronym 'SRIM' in large, blue, metallic letters at the top. Below it, the full name 'The Stopping and Range of Ions in Matter' is written in a smaller, blue, 3D font. The text is set against a background of a red and blue pixelated, circular pattern that resembles a splash or a burst of energy.

SRIM

The Stopping and Range of Ions in Matter

*Activation Technique in
Investigation of Excitation
Functions of Protons Induced
Reactions on Cyclotron C18*

Motivation

*Nuclear data evaluation is generally carried out on the basis of experimental data and theoretical model calculations **RIPL (Reference Input Parameter Library)**. It is both practically and economically impossible to measure necessary cross-sections for all the isotopes in the periodic table for a wide range of energies. Therefore, nuclear reaction model calculations play an important role in the nuclear data evaluation.*

Surveying the information of excitation functions and yields of the reactions has shown that:

- published cross sections have relatively high errors , the excitation functions were measured in not enough detailed;**
- the reported cross sections from different groups often showed unacceptable deviations both in the values of the cross sections and in their energy scales;**
- reported calculated and/or measured thick target integral yields have significant differences.**

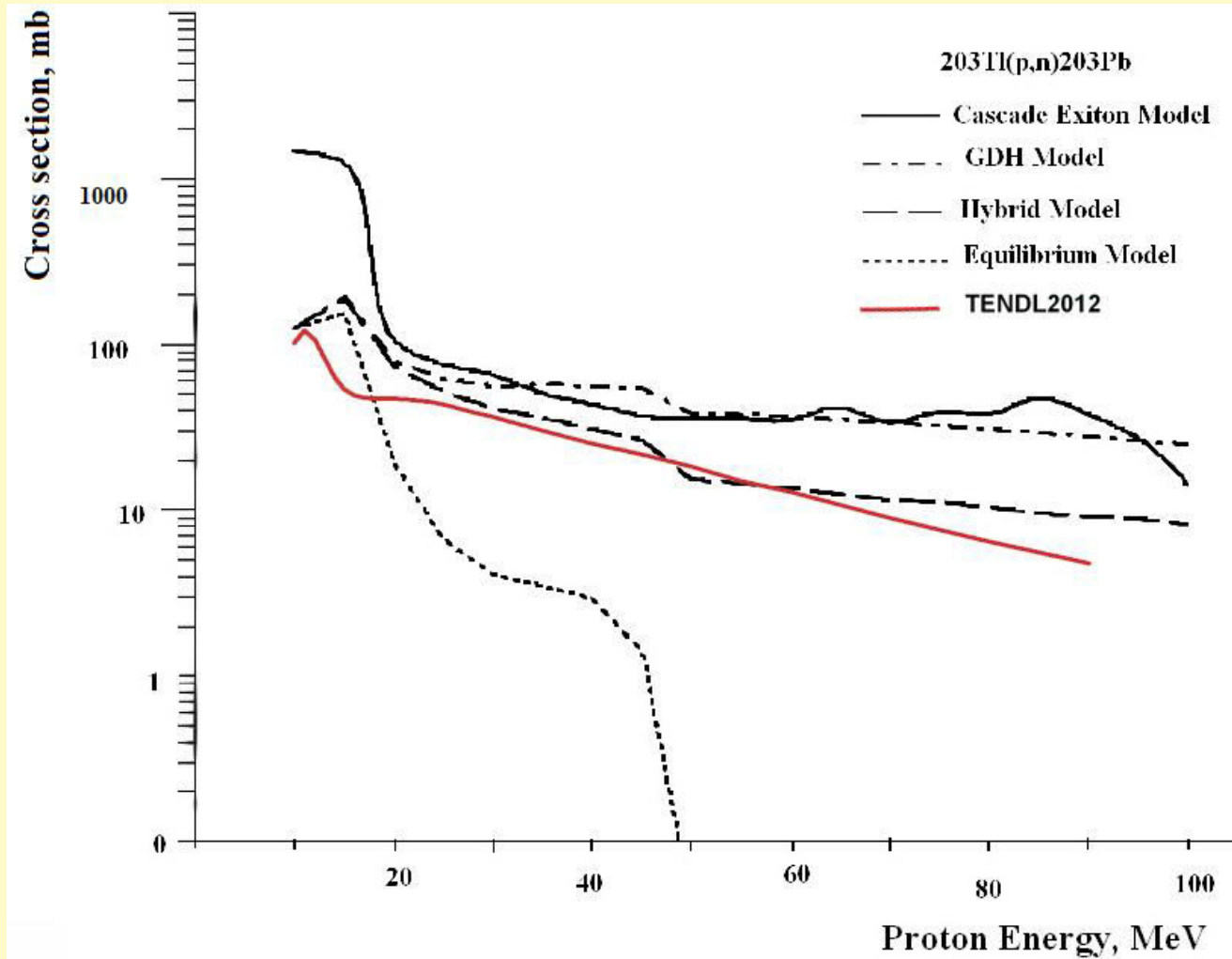

A. Kaplan, A. Ydin, E. Tel and A. Sarer, “Equilibrium and pre-equilibrium emissions in proton-induced reactions on $^{203};^{205}\text{Tl}$ ”, *Pramana-J. Phys.*, Vol. 72, No. 2, (2009)

$^{203}\text{Tl}(p,2n)^{202}\text{Pb}$

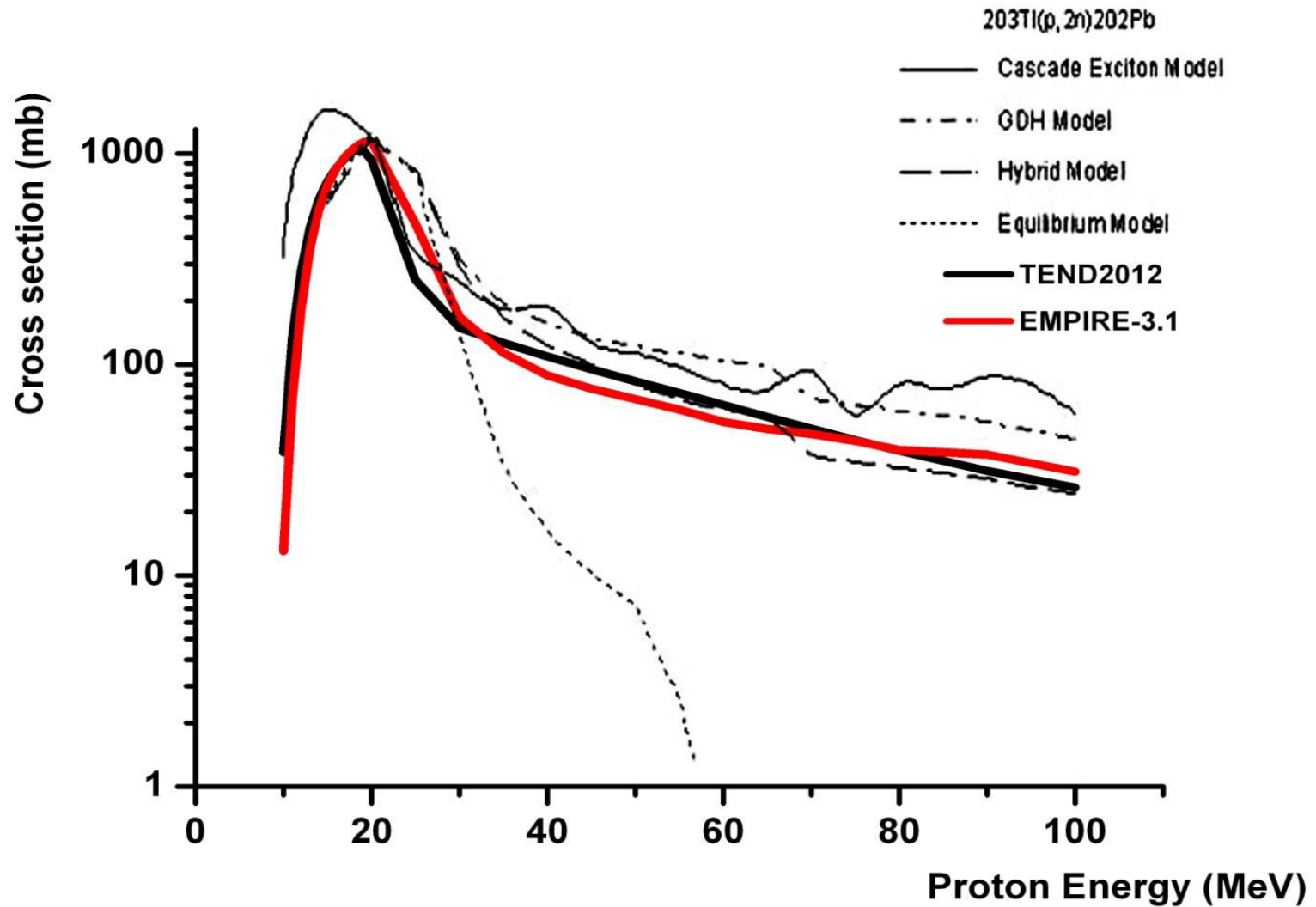

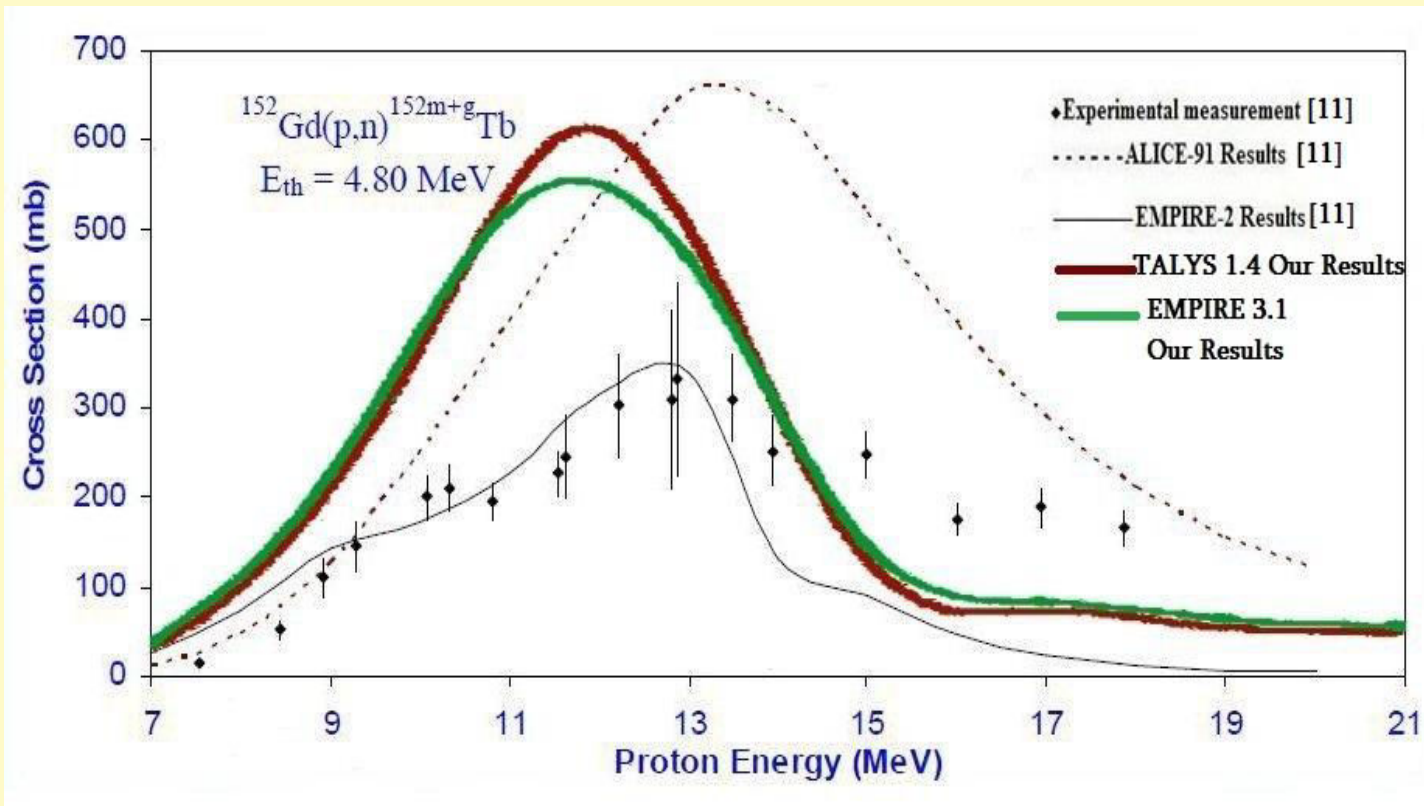

M.B. Challan, G.S. Moawad, M.A. Abou-Zeid, and M.N.H. Comsan,
Excitation functions of radionuclides produced by proton induced
reactions on gadolinium targets, 6th Conference on Nuclear and Particle
Physics 17-21 Luxor, Egypt Nov. 2007

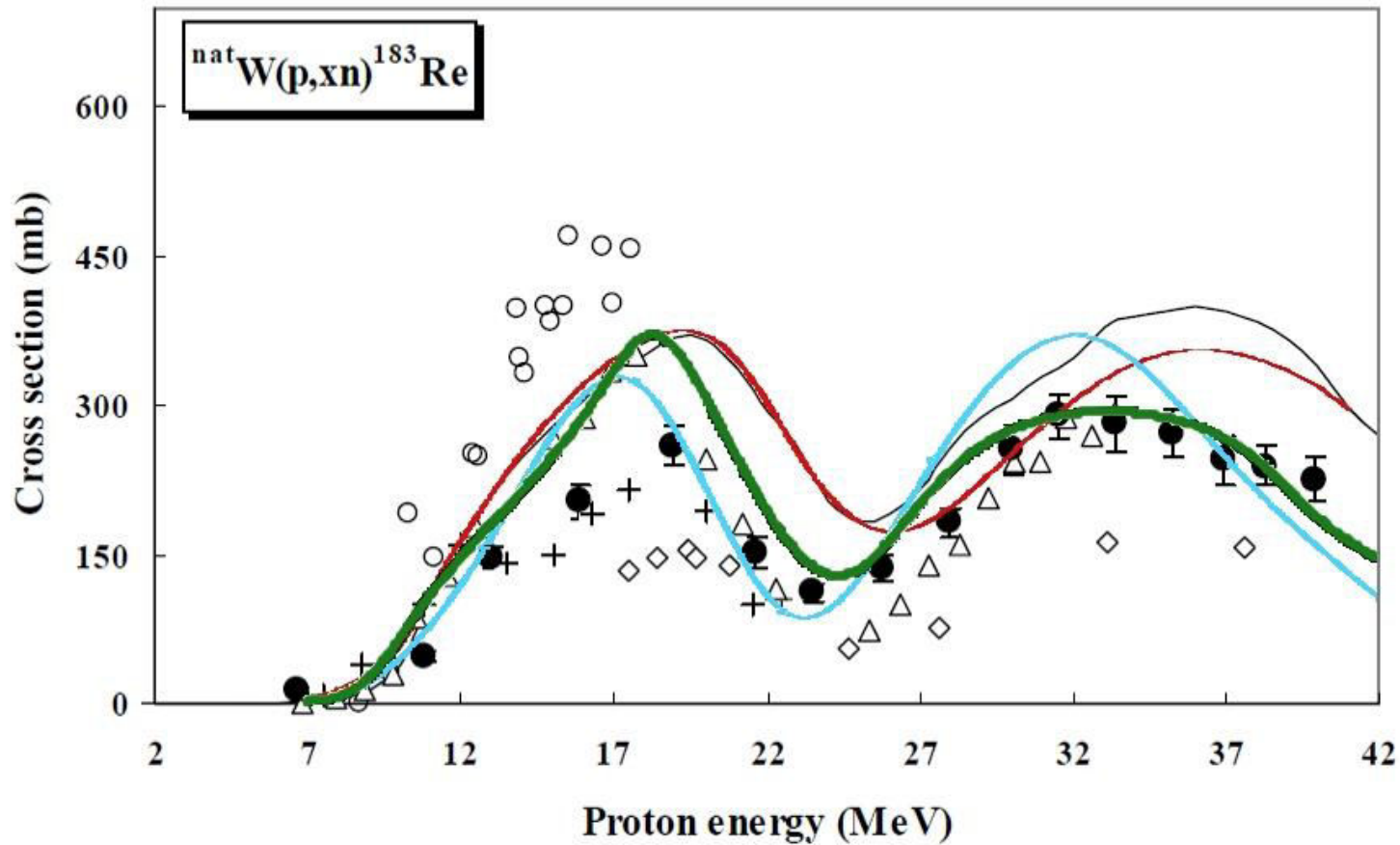

◇ - Schoen et al. (1979), + - Zhang et al. (1999), o - Lapi et al. (2006),

△ - Tarkanyi et al. (2006), • - Khandeker et al. (2007)

— ALICE-IPPE, Our calculations: - - - EMPIRE-3.1, - - - Talys 1.4,

- - - TENDL2012

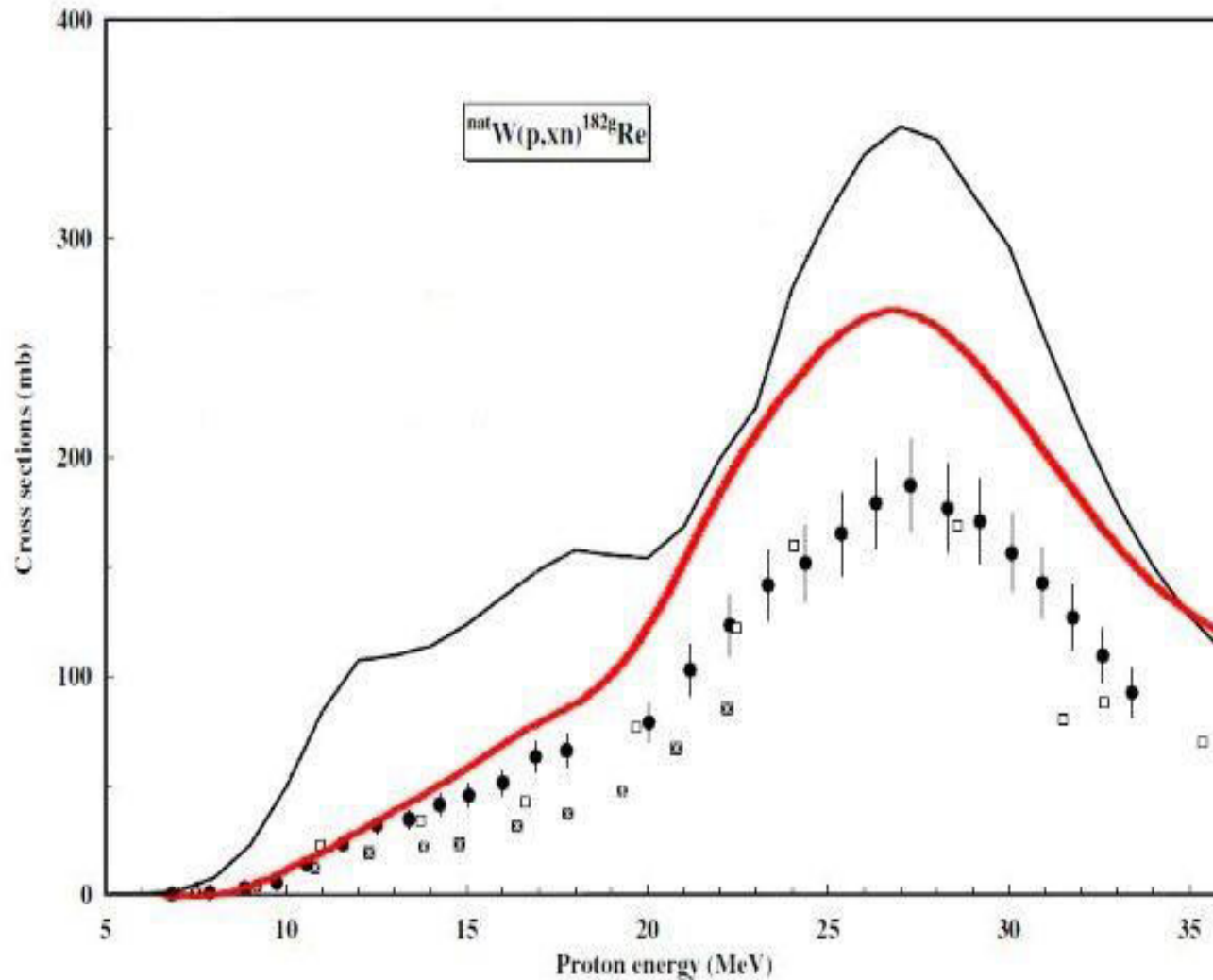

- F. Tarkanyi (2006), * Zhang (1999), □ Michel (2005),
Curves: — MENDL 2P, — TALYS 1.4 (Our result)

Cyclotron C18/18





Target: ^{nat}W , ^{nat}Gd and ^{203}Tl

Al : beam degrader, catcher

Cu: monitor

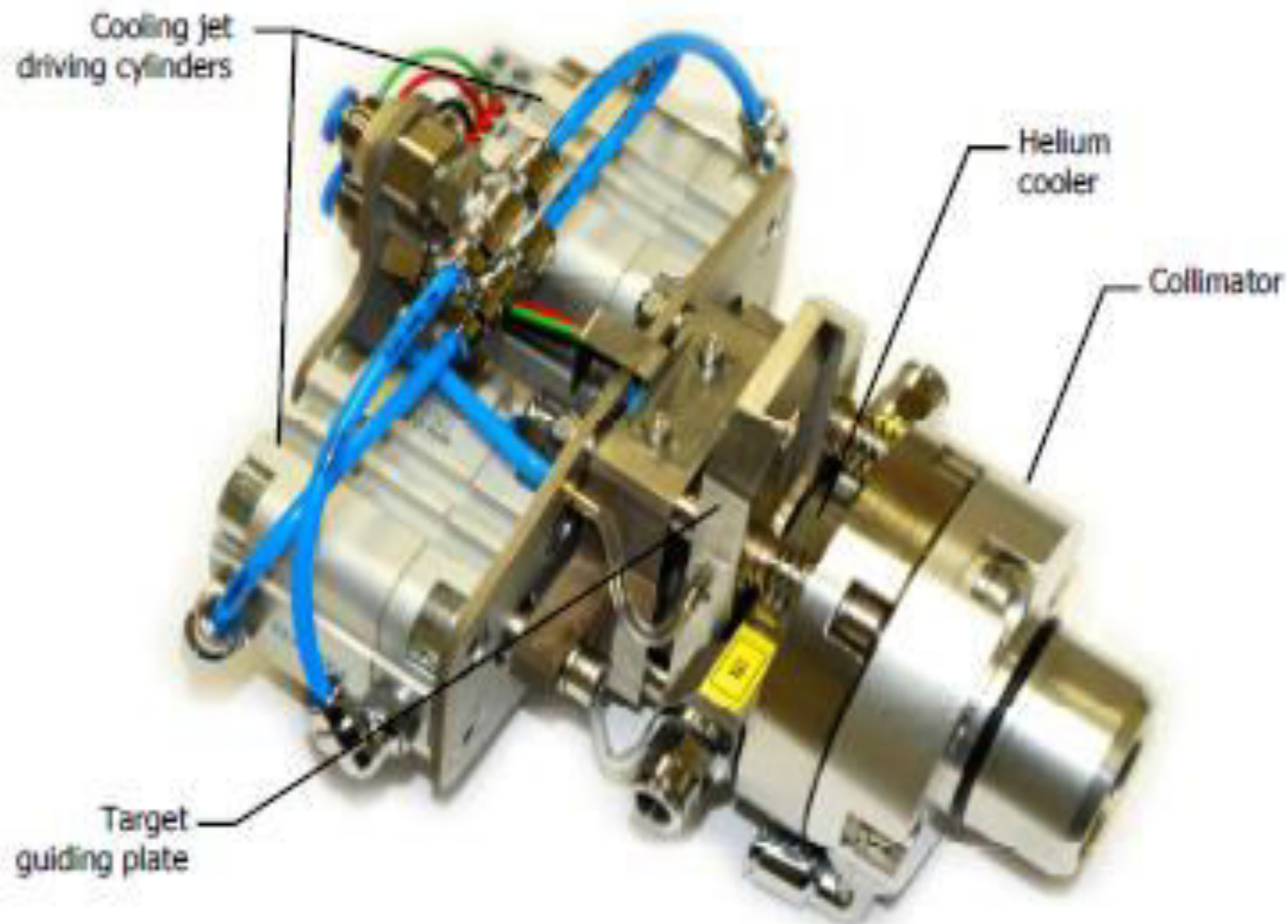
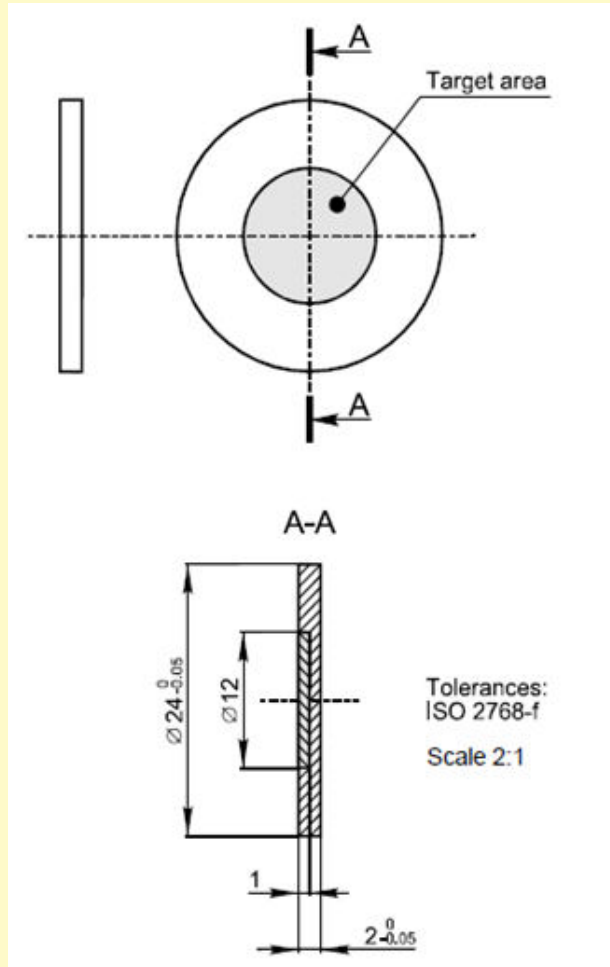

Figure 1.3. Basic parts of Nirta Solid Compact.

Target disc sizes and design



If you order:

- *NSC-TS06-IBA-HA-200 – you will get Havar window foil of 200 μm thickness;*
- *NSC –TS06-ISO-TI-050 - you will get Titanium window foil of 50 μm thickness;*
- *NSC-TS06-IBA-AL-500 you will get Aluminum window foil of 500 μm thickness (default configuration for iodine production).*

Havar[®] - High-Strength Non-Magnetic Alloy

Co42.5/Cr20/Ni13/Fe/W/Mo/Mn – 8.3 g/cm³,

Melting point - 1480 °C

Aluminum – 2.7 g/cm³,

Melting point - 660 °C

Titanium - 4.5 g/cm³,

Melting point - 1668 °C

6.4 Beam energy degradation by the window foil

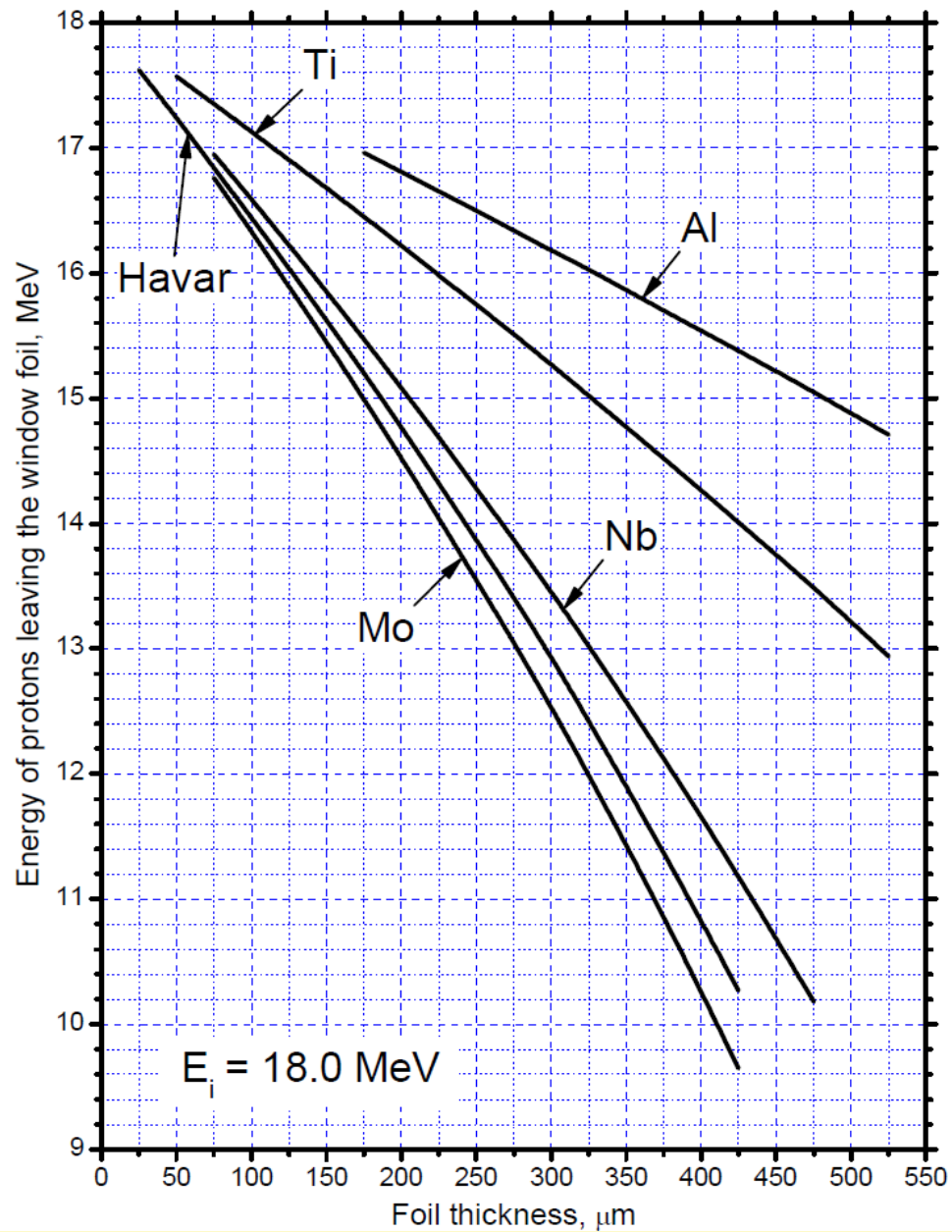

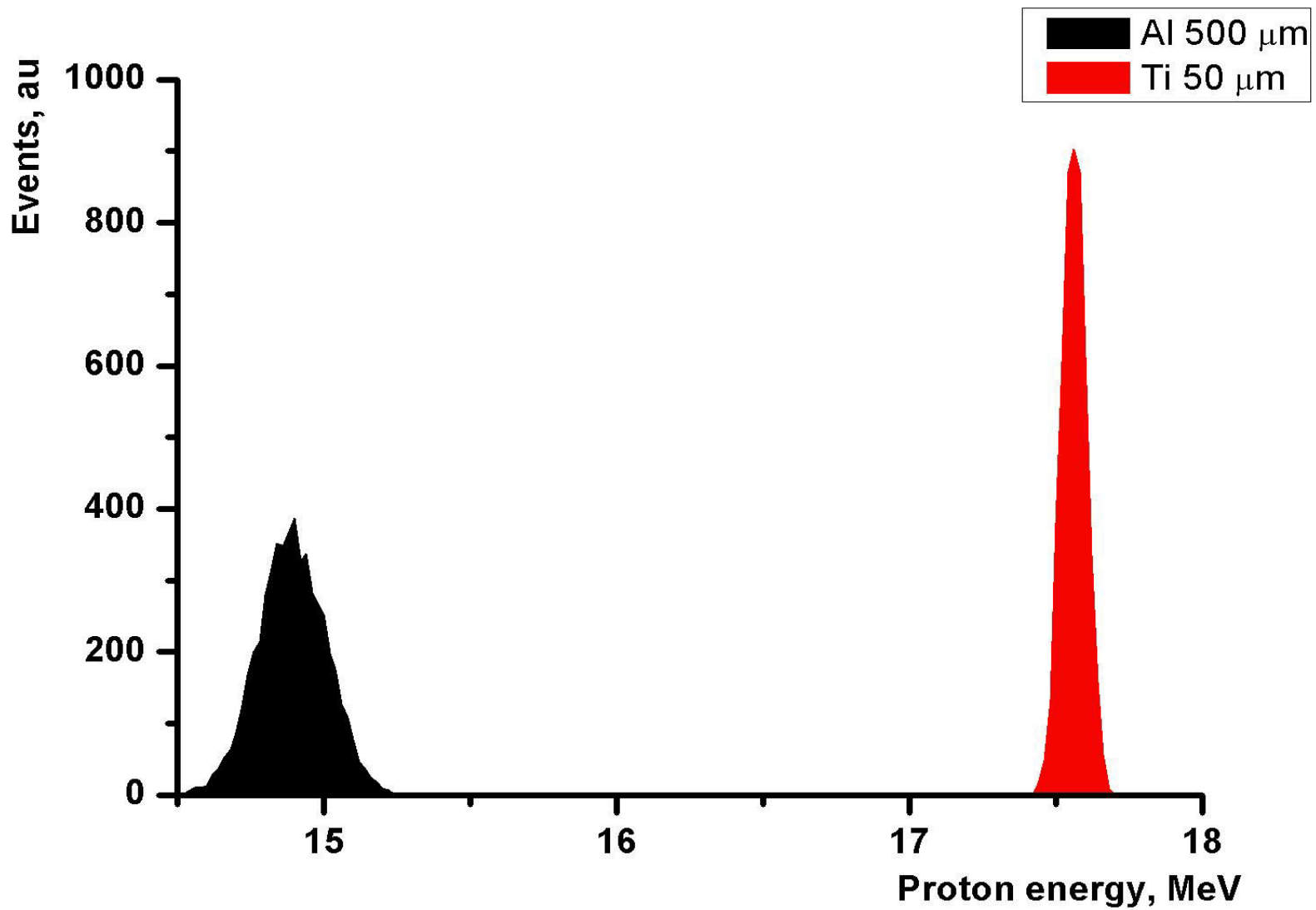

In case of foil of the window:

Titanium with thickness 50 μm proton beam energy will be $17.57 \pm 0.040 \text{ MeV}$.

Aluminum foil with thickness 500 μm proton beam energy will be $14.88 \pm 0.129 \text{ MeV}$.

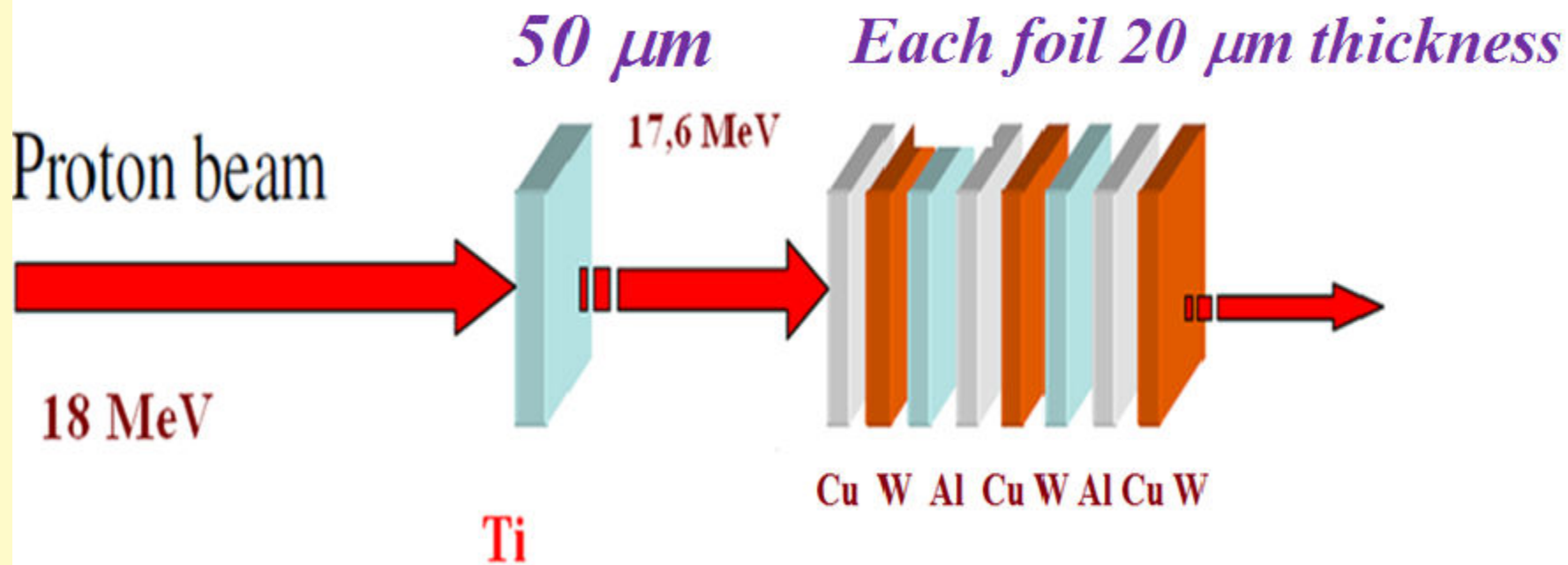

^{nat}W(p,xn)^{182m,182g,183,184m,184g,186g}Re

Isotope	Natural abundance, %
¹⁸⁰W	0.12
¹⁸²W	26.50
¹⁸³W	14.31
¹⁸⁴W	30.64
¹⁸⁶W	28.43

Nuclei	Half-life	Reactions	Threshold, MeV	E, keV	Intensity, (%)
^{181}Re	20 h	$^{182}\text{W}(\text{p},2\text{n})$	10.5	365.57	57.
$^{182\text{g}}\text{Re}$	64 h	$^{182}\text{W}(\text{p},\text{n})$	3.58	169.15	11.3
		$^{183}\text{W}(\text{p},2\text{n})$	9.77		
$^{182\text{m}}\text{Re}$	12.7 h	$^{182}\text{W}(\text{p},\text{n})$	3.58	470.32	2.
		$^{183}\text{W}(\text{p},2\text{n})$	9.77		
^{183}Re	70 d	$^{183}\text{W}(\text{p},\text{n})$	1.35	162.32	23.3
		$^{184}\text{W}(\text{p},2\text{n})$	8.75		
$^{184\text{g}}\text{Re}$	38 d	$^{184}\text{W}(\text{p},\text{n})$	2.27	792.07	37.5
$^{184\text{m}}\text{Re}$	169 d	$^{184}\text{W}(\text{p},\text{n})$	2.27	104.73	13.4
^{186}Re	3.72 d	$^{186}\text{W}(\text{p},\text{n})$	1.36	137.16	9.42

SRIM (*Stopping and Range of Ions in Matter*) is a group of programs which calculate the stopping and range of ions (up to 2 GeV/amu) into matter using a quantum mechanical treatment of ion-atom collisions

TRIM (*Transport of Ions in Matter*)

SSSM (*SRIM Support Software Module*)

The beam-energy degradation and proton range in the W-target stack was determined using the computer code SRIM-2013

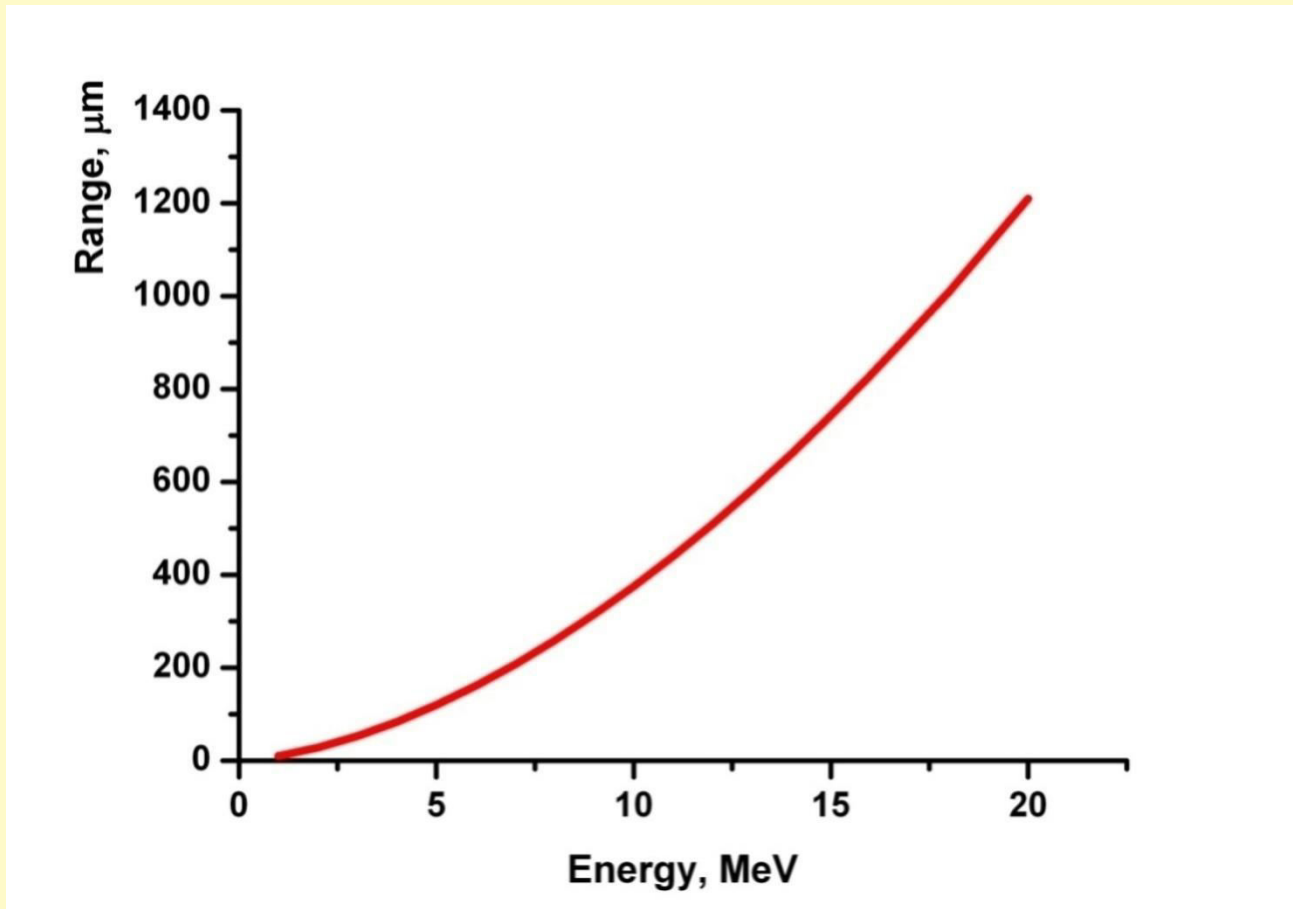

For the determination of optimum target thickness and calculation of proton beam energy degradation for all investigated nuclei SRIM-2013 (SRIM/TRIM – Stopping and Range of Ion in Matter/Transport of Ions in Matter)_nuclear code was used.

Calculation of proton beam energy degradation

The screenshot displays the SRIM-2006.02 software interface. The main window is titled 'TRIM Input' and shows the 'TRIM (Monte Carlo Ranges)' calculation type. The 'ION DATA' section shows a proton beam with an energy of 45000 keV. The 'TARGET DATA' section shows a multi-layer target consisting of 23 layers of Al, Cu, Zn, and Al. The 'Special Parameters' section shows the stopping power version as SRIM-2003. The 'Output Disk Files' section shows the calculation results. The 'Calculation Parameters' section shows the ion type as H, ion energy as 45 MeV, and ion angle as 0 degrees. The 'ION STATS' section shows the range and straggle for the ion. The 'SPUTTERING YIELD' section shows the yield for the target materials. The 'XY Longitudinal' plot shows the depth vs Y-axis for the ion beam.

Layer Name	Width (Å)	Density	Al (26.982)	Cu (63.54)	Zn (65.39)	Al (26.982)
1 Al	1000000	2.702	1.00000	0.00000	0.00000	0.0
2 Cu	0.1490116	8.930	0.00000	1.00000	0.00000	0.0
3 Zn	0.01490116	7.140	0.00000	0.00000	1.00000	0.0

Range	Straggle
Longitudinal	5.28 nm 947.44
Lateral Proj	1.33 nm 1.66 nm
Radial	2.17 nm 1.03 nm

Atom/ion	eV/Atom
TOTAL	0.000000
Al	0.000000
Cu	0.000000
Zn	0.000000

<http://www.srim.org>

- SRIM(The Stopping and Range of Ions in Matter) : Monte Carlo Transport Calculation
- Calculate the stopping and range of ions

Transport of protons through stack

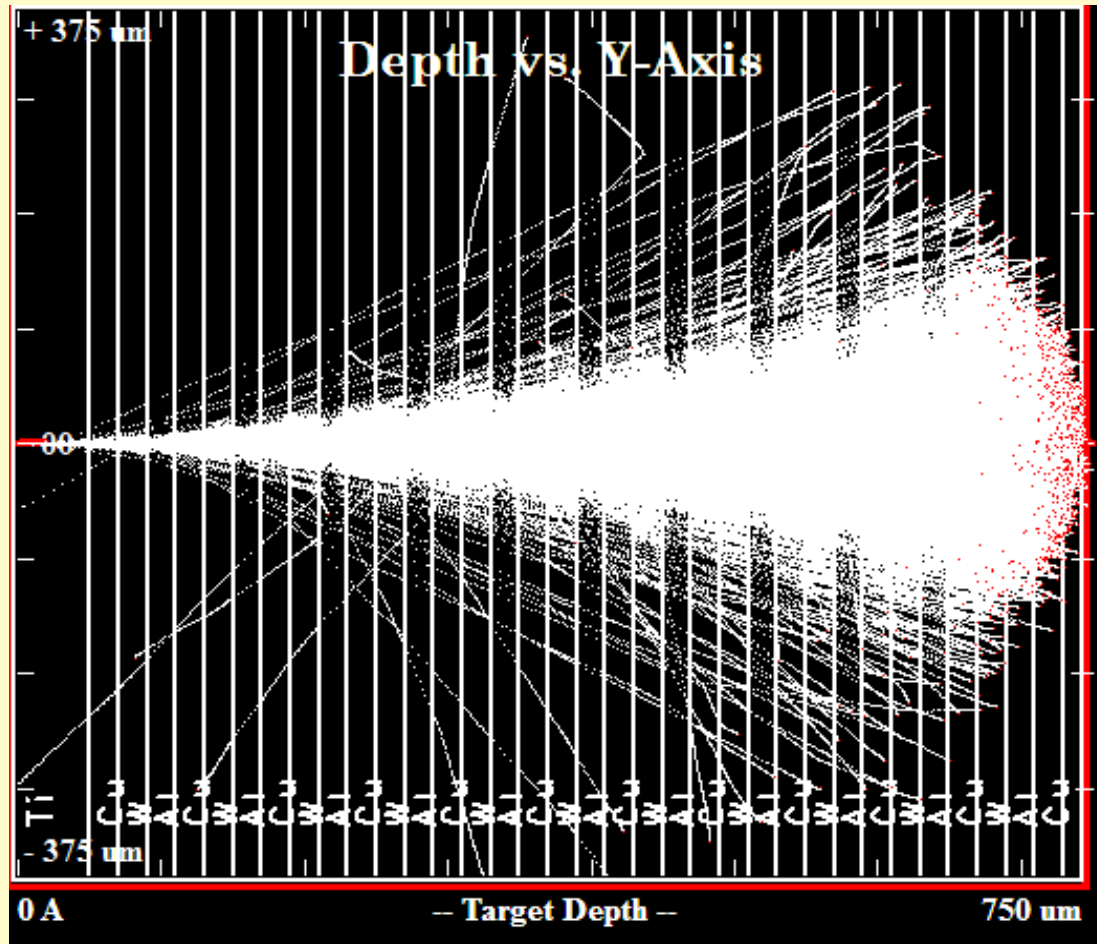

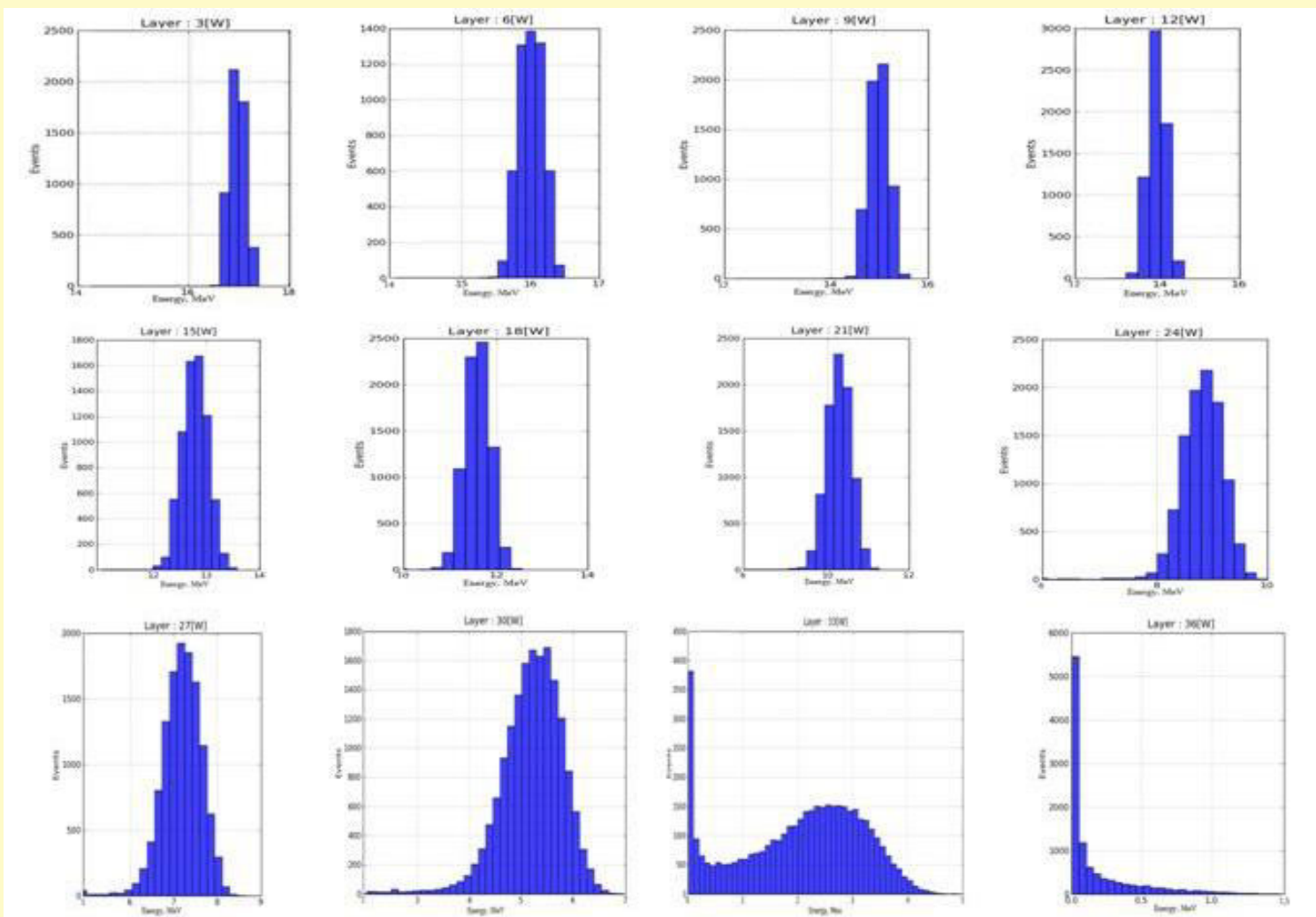

Energy distribution of proton beam at W foils

W foil number	Energy, MeV
1	16.96 ± 0.165
2	16.00 ± 0.18
3	14.87 ± 0.22
4	13.76 ± 0.273
5	12.71 ± 0.3
6	11.45 ± 0.386
7	10.15 ± 0.53
8	8.77 ± 0.66
9	7.11 ± 0.78
10	5.07 ± 0.97
11	2.01 ± 1.15

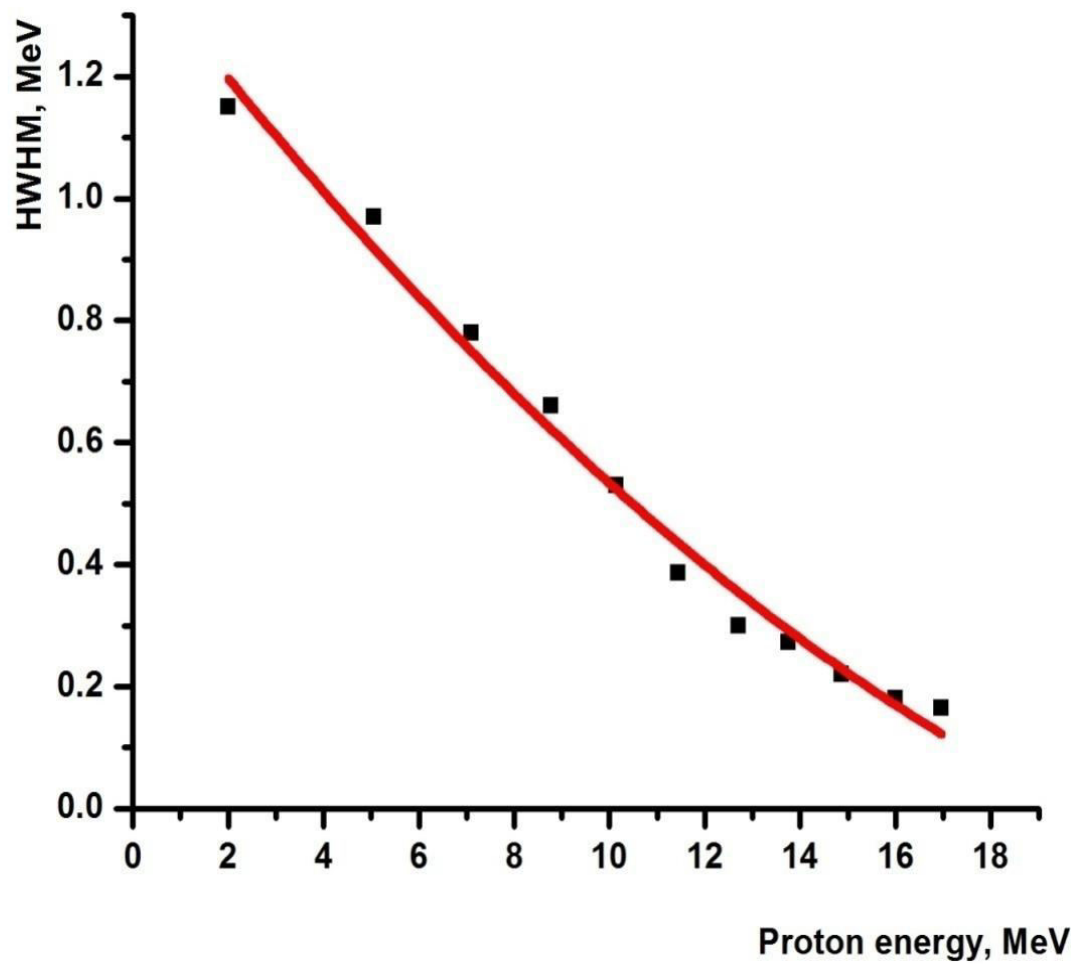

After irradiation the stacks are disassembled, so that W and Cu corresponding foils can be taken together for subsequent γ -ray spectroscopy.

Detector HPGe – ORTEC

Analyzer DSPEC-LF Digital +MAESTRO

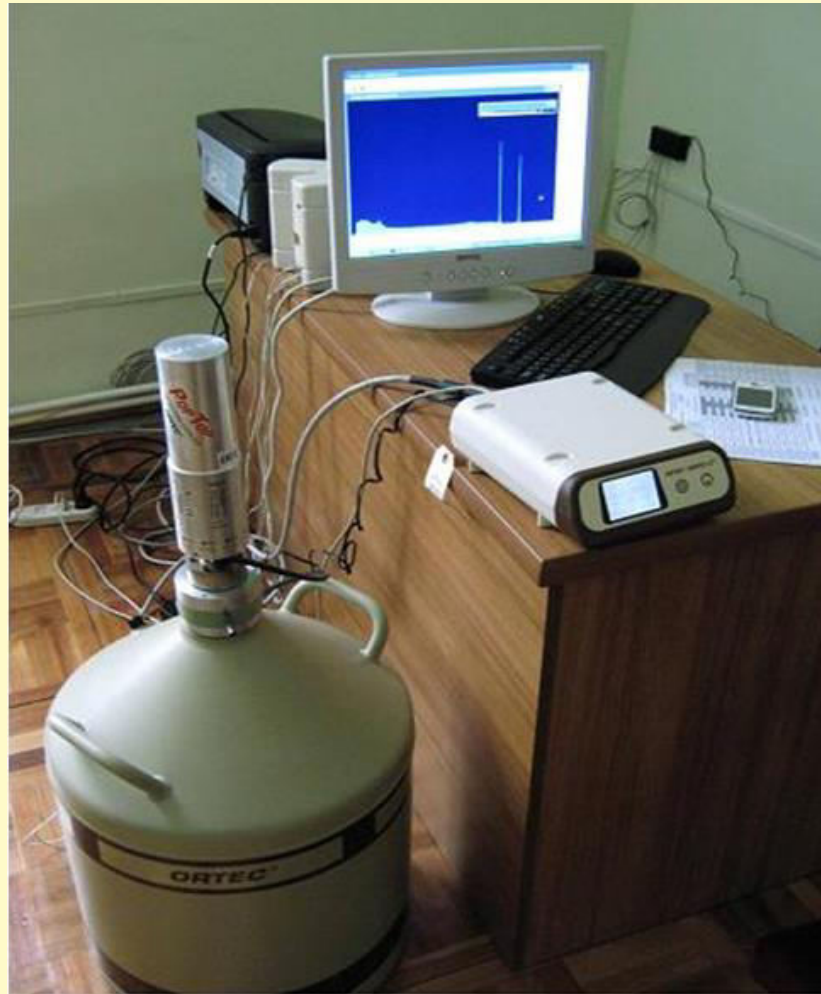

$$\sigma = \frac{\lambda C}{\varepsilon * I_{\gamma} * N_d * l * \phi (1 - e^{-\lambda t_m}) e^{-\lambda t_c} (1 - e^{-\lambda t_i})}$$

λ - the decay constant of isotope of interest,

$\lambda = 0.693/T_{1/2}$;

C – total counts of gamma-ray peak area;

ε - the efficiency of the detector for the radiation of interest;

I_{γ} - the branching ratio or intensity of the gamma ray of interest;

N_d - atomic density (atom/cm³);

l - foil thickness, cm

ϕ - the incident proton flux (p/cm²/s);

t_c, t_m, t_i - the cooling time, measuring time, irradiating time (s).

Determination of beam flux

$$\phi = \frac{\lambda C}{\varepsilon \times I_{\gamma} \times N_d \times t \times \sigma (1 - e^{-\lambda t_m}) e^{-\lambda t_c} (1 - e^{-\lambda t_i})}$$

For Cu cooper

*Monitor Reactions. Protons.
Deuterons. ^3He -particles. Alpha-
particles.*

*[http://www-
nds.iaea.org/medical/monitor_reac
tions.html](http://www-nds.iaea.org/medical/monitor_reactions.html)*

Table of NMR-active nucleus properties of copper

<i>Isotopes</i>	<i>Natural abundance, %</i>	<i>Reactions</i>	<i>Threshold, MeV</i>	<i>Half-life</i>	<i>Eγ, keV</i>	<i>Intensity, %</i>
^{63}Cu	69.17	$^{nat}\text{Cu}(p,x) ^{62}\text{Zn}$	4.21	9.186 h	596.56 507.6	26. 14.8
^{65}Cu	30.83	$^{nat}\text{Cu}(p,x) ^{65}\text{Zn}$	2.17	244.26 d	1115.55	50.60



$$\sigma = \frac{\lambda C}{\varepsilon \times I_{\gamma} \times N_d \times t \times \phi (1 - e^{-\lambda t_m}) e^{-\lambda t_c} (1 - e^{-\lambda t_i})}$$

For investigated nuclei

The total errors associated with cross section measurements is calculated by quadratic summing the possible individual relative errors:

- *Counting statistics;*
- *Detector efficiency;*
- *Decay data;*
- *Number of target nuclei;*
- *Incident bombarding particle intensity.*

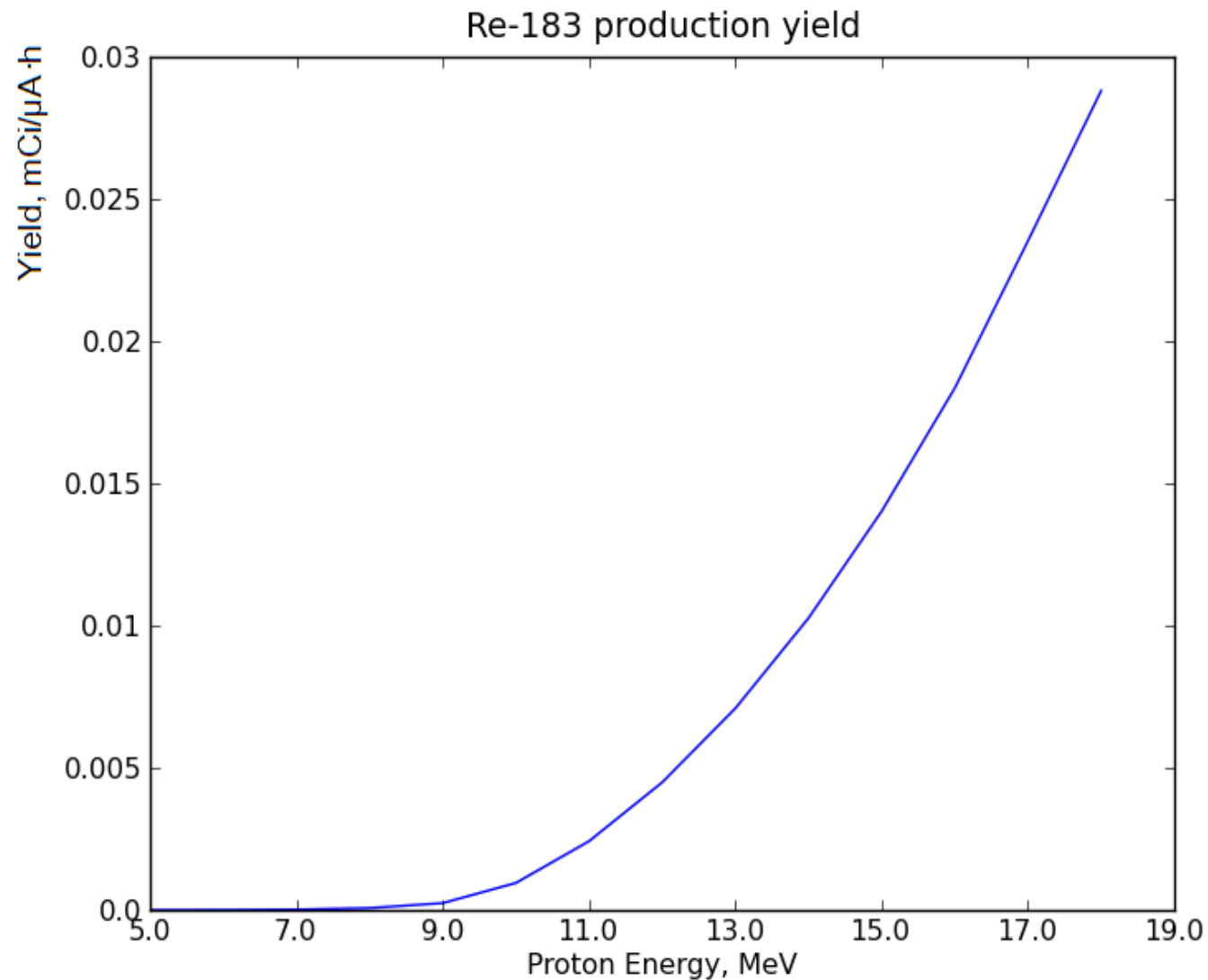
$$Y = 6.24 \times 10^{12} \times \frac{N_A}{M} \int_{E_{out}}^{E_{in}} \frac{\sigma(E)}{S(E)} dE$$



Calculated by TALYS isomer ratio $\sigma(^{182g}\text{Re})/\sigma(^{182m}\text{Re})$

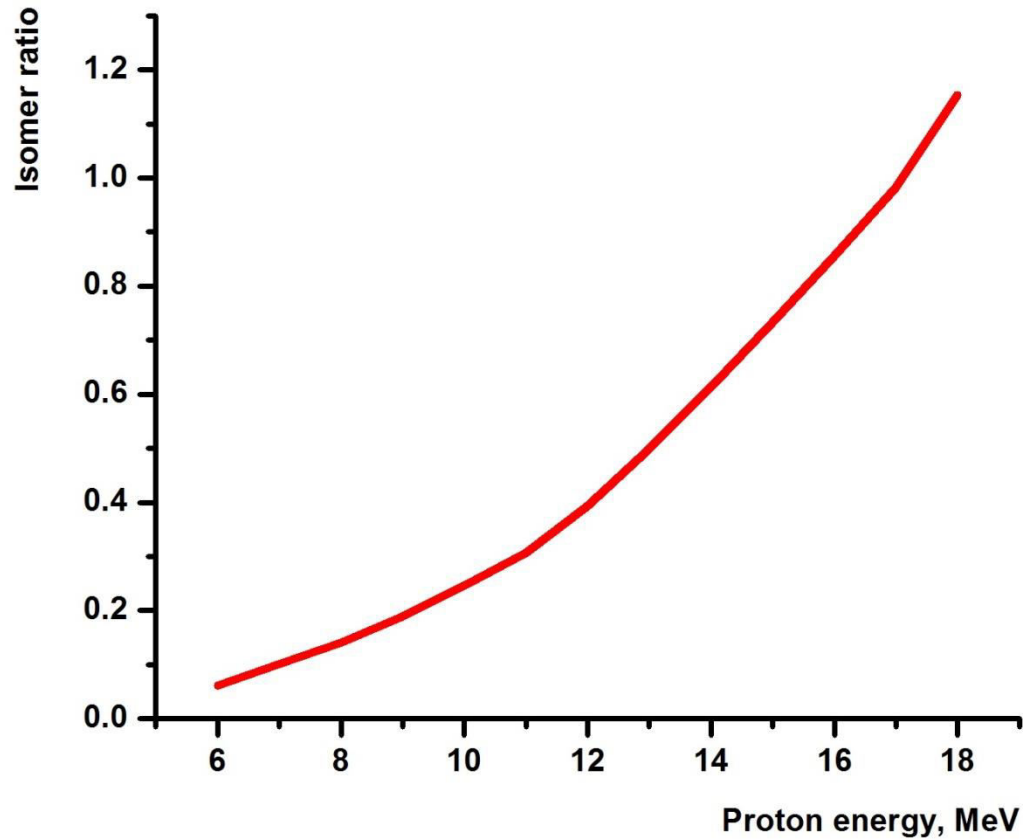

Publications

1. R.Avakian, G.Bazoyan, M.Hakobyan, I.Kerobyan, “The Possibility of the Neutron Beams Formation on Base of Cyclotron C18”, Procc. X International Symposium “RREPS-13” and “Meghri-13”, September 23-27, 2013, Yerevan, Armenia
2. R.Avagyan, R.Avetisyan, G.Bazoyan, M.Hakobyan, I.Kerobyan, “Evaluation of the yields of Ga-67 produced on cyclotron C18”, AJP 7(2) 2014
3. A.Avetisyan, R.Avagyan, R.Dallakyan, I.Kerobyan “Photo-production of $^{99}\text{Mo}/^{99\text{m}}\text{Tc}$ with electron linear accelerator beam”, Nuclear Medicine and Biology (Accepted for publication)
4. А.С.Данагулян, Г.О.Оганесян, Т.М.Бахшиян, Р.О.Авакян, А.Э.Аветисян, И.А.Керобян, Р.К.Даллакян “Фотоядерные реакции на мишенях $^{112,116,124}\text{Sn}$, ^{116}Te , ^{177}Hf “, Ядерная Физика
5. A.Danagulyan, G.Hovhanissyan, T.Bakhshiyanyan, R.Avagyan, A.Avetisyan, I.Kerobyan, R.Dallakyan “Formation of the medical radionuclides ^{111}In , $^{117\text{m}}\text{Sn}$, ^{124}Sb and ^{177}Lu in photonuclear reactions”, Applied Radiation and Isotopes

THANK YOU!

Publications

- 1. R.H.Avagyan, A.E.Avetisyan, I.A.Kerobyan, S.P.Taroyan, The Applied Physics at Yerevan Physics Institute, Proceedings of National Academy of Science of Armenia, 44, 5, 2009, pp. 380-388.**
- 2. R.H.Avagyan, A.E.Avetisyan, I.A.Kerobyan et al., Experimental Plant for Investigation of the Possibility of Production of Medicine Intended Isotopes on the Base of Linear Accelerator, 47, 1, 2012, pp. 9-16.**
- 3. A.Avetisyan, R.Avagyan, R.Dallakyan, I.Kerobyan, “ ^{99m}Tc photo-production under electron linear accelerator beam”, Armenian Journal of Physics, 2013, vol. 6, issue 1, pp. 35-44.**
- 4. R.Avakian, G.Bazoyan, M.Hakobyan, I.Kerobyan, “The Possibility of the Neutron Beams Formation on Base of Cyclotron C18”, Procc. X International Symposium “RREPS-13” and “Meghri-13”, September 23-27, 2013, Yerevan, Armenia**
- 5. R.Avagyan, R.Avetisyan, G.Bazoyan, M.Hakobyan, I.Kerobyan, “Evaluation of the yields of Ga-67 produced on cyclotron C18”, AJP 7(2) 2014**
- 6. A.Avetisyan, R.Avagyan, R.Dallakyan, I.Kerobyan “Photo-production of $^{99}\text{Mo}/^{99m}\text{Tc}$ with electron linear accelerator beam”, Nuclear medicine and Biology**